

Documento descargado de:

<http://electronica.webcindario.com/>

LM350

3-Terminal 3A Positive Adjustable Voltage Regulator

Features

- Output adjustable between 1.2V and 33V
- Guaranteed 3A output current
- Internal thermal overload protection
- Load regulation (Typ: 0.1%)
- Line regulation (Typ: 0.015%/V)
- Internal short-circuit current limit
- Output transistor safe-area compensation

Description

The LM350 is an adjustable 3-terminal positive voltage regulator capable of supplying in excess of 3.0 A over an output voltage range of 1.2V to 33 V

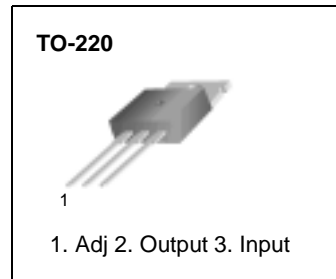

Internal Block Diagram

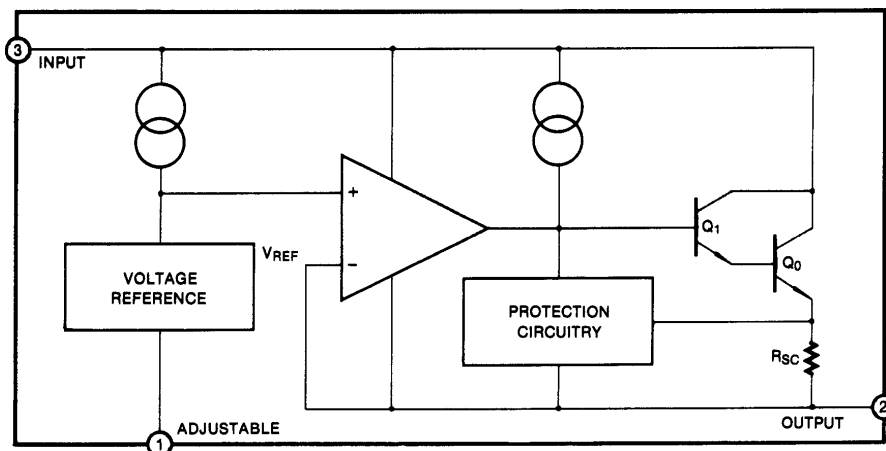

Absolute Maximum Ratings

Parameter	Symbol	Value	Unit
Input-Output Voltage Differential	$V_I - V_O$	35	V _{DC}
Lead Temperature (Soldering, 10sec)	T _{LEAD}	300	°C
Power Dissipation	P _D	Internally limited	-
Operating Temperature Range	T _{OPR}	0 ~ +125	°C
Storage Temperature Range	T _{STG}	-65 ~ +150	°C

Electrical Characteristics

($V_I - V_O = 5V$, $I_O = 1.5A$, $T_J = 0^\circ C$ to $+125^\circ C$; $P_D \leq P_{DMAX}$, unless otherwise specified)

Parameter	Symbol	Conditions	Min.	Typ.	Max.	Unit
Line Regulation (Note1)	R _{line}	$T_A = +25^\circ C$, $3V \leq V_I - V_O \leq 35V$	-	0.015	0.03	%/V
Load Regulation (Note1)	R _{load}	$T_A = +25^\circ C$, $3V \leq V_I - V_O \leq 35V$ $V_O \leq 5V$ $V_O \geq 5V$	-	5 0.1	25 0.5	mV %
Adjustment Pin Current	I _{ADJ}	-	-	50	100	μA
Adjustment Pin Current Change	ΔI _{ADJ}	$3V \leq V_I - V_O \leq 35V$, $10mA \leq I_O \leq 3A$, $P_D \leq P_{MAX}$	-	0.2	5.0	μA
Thermal Regulation	REG _T	Pulse = 20ms, $T_A = +25^\circ C$	-	0.002	-	%/W
Reference Voltage	V _{REF}	$3V \leq V_I - V_O \leq 35V$, $10mA \leq I_O \leq 3A$, $P_D \leq 30W$	1.2	1.25	1.30	V
Line Regulation	R _{line}	$3.0V \leq V_I - V_O \leq 35V$	-	0.02	0.07	%/V
Load Regulation	R _{load}	$10mA \leq I_O \leq 3.0A$ $V_O \leq 5.0V$ $V_O \geq 5.0V$	-	20 0.3	70 1.5	mV %
Temperature Stability	ST _T	$T_J = 0^\circ C$ to $+125^\circ C$	-	1.0	-	%
Maximum Output Current	I _{O(MAX)}	$V_I - V_O \leq 10V$, $P_D \leq P_{MAX}$	3.0	4.5	-	A
		$V_I - V_O = 30V$, $P_D \leq P_{MAX}$, $T_A = +25^\circ C$	0.25	1.0	-	A
Minimum Load Current	I _{L(MIN)}	$V_I - V_O = 35V$	-	3.5	10	mA
RMS Noise, %of V _{OUT}	V _N	$10Hz \leq f \leq 10KHz$, $T_A = +25^\circ C$	-	0.003	-	%/V _O
Ripple Rejection	RR	$V_O = 10V$, $f = 120Hz$, C _{ADJ} = 0 C _{ADJ} = 10μF	66	65 80	-	dB dB
Long-Term Stability	ST	$T_J = +125^\circ C$	-	0.3	1	%/ 1000HR

Note:

1. Regulation is measured at constant junction temperature. Changes in output voltage due to heating effects must be taken into account separately. Pulse testing with low duty cycle is used.

Typical Performance Characteristics

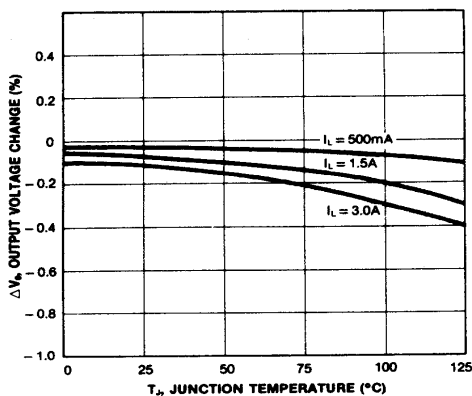

Figure 1. Load Regulation

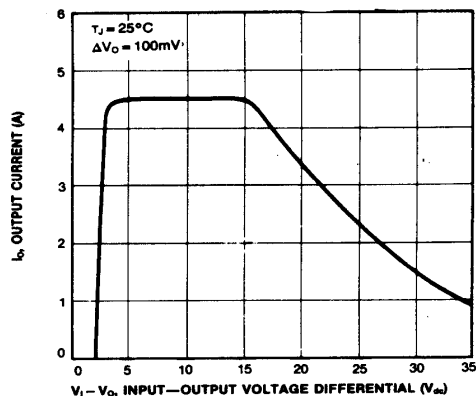

Figure 2. Current Limit

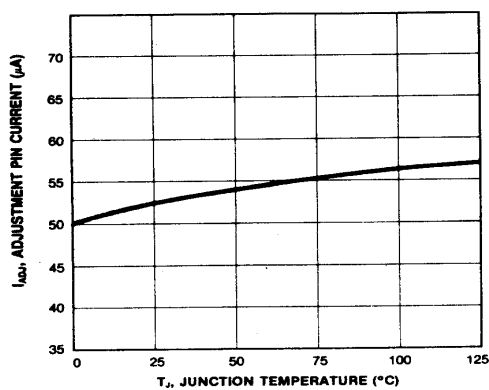

Figure 3. Adjustment Pin Current

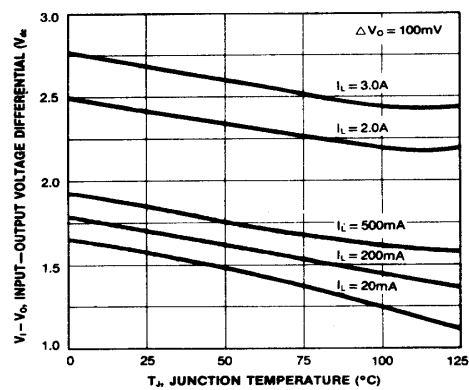

Figure 4. Dropout Voltage

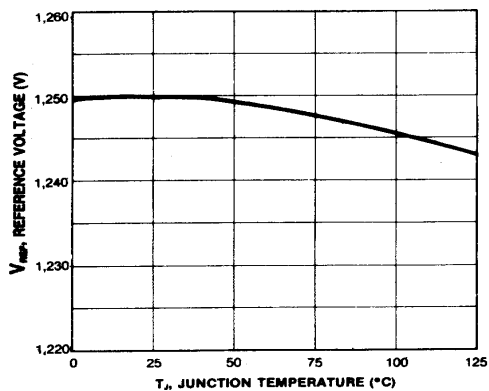

Figure 5. Temperature Stability

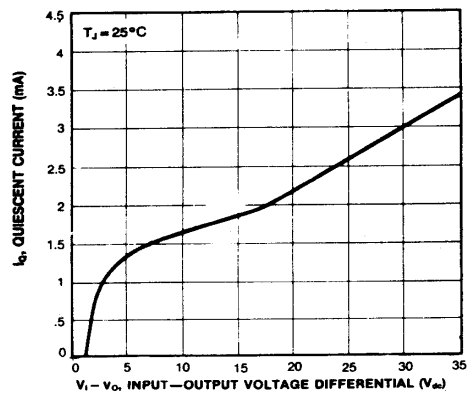

Figure 6. Minimum Load Current

Typical Performance Characteristics (continued)

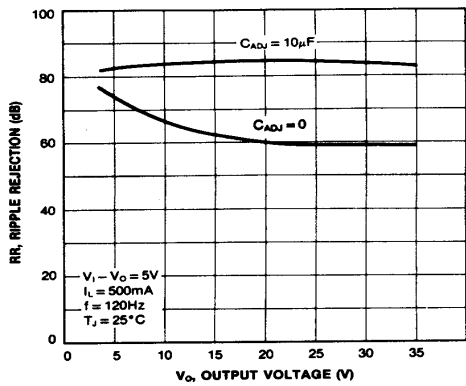

Figure 7. Ripple Rejection vs Vo

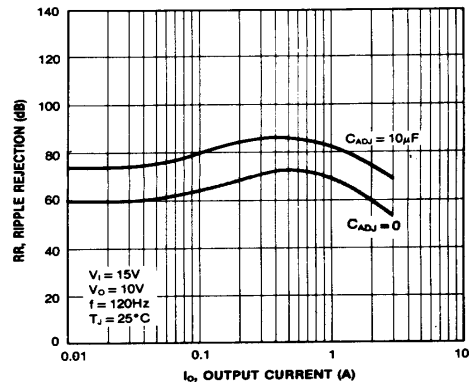

Figure 8. Ripple Rejection vs Io

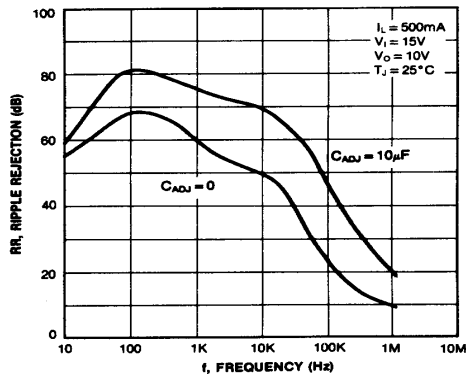

Figure 9. Ripple Rejection vs Frequency

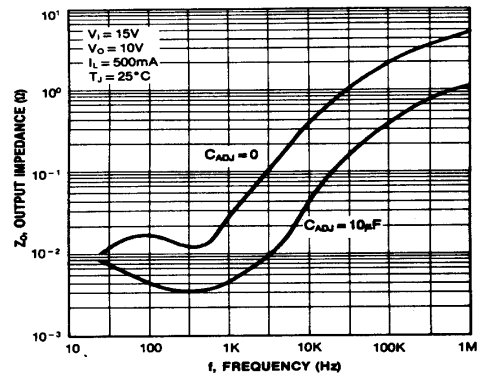

Figure 10. Output Impedance

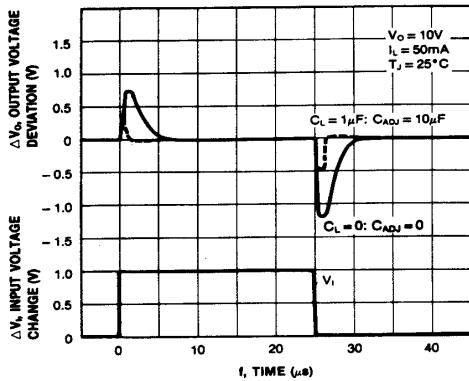

Figure 11. Line Transient Response

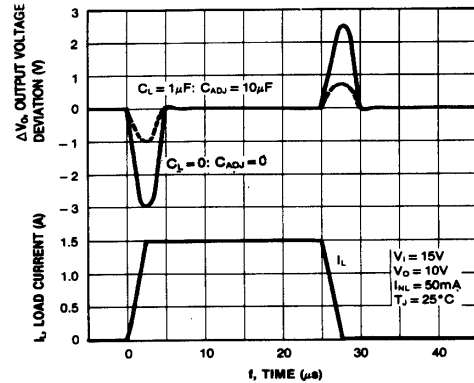

Figure 12. Load Transient Response

Typical Application

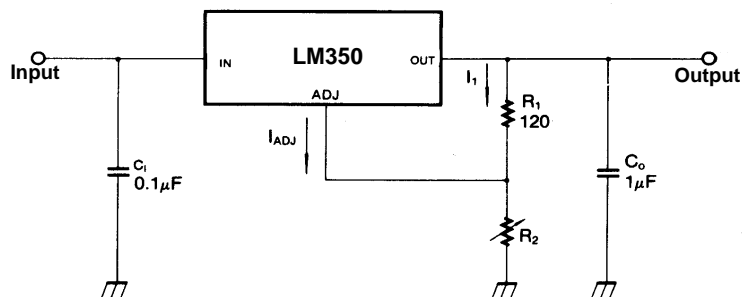

Figure 13.

C_I : C_I is required if the regulator is located an appreciable distance from power supply filter.

C_O : Output capacitors in the range of $1\mu\text{F}$ to $100\mu\text{F}$ of aluminum or tantalum electronic are commonly used to provide improved output impedance and rejection of transients.

In operation, the LM350 develops a nominal 1.25V reference voltage, V_{REF} , between the output and adjustment terminal. The reference voltage is impressed across program resistor R_1 and, since the voltage is constant, a constant current I_1 then flows through the output set resistor R_2 , giving an output voltage of

$$V_O = 1.25V(1+R_2/R_1) + I_{ADJ} R_2$$

Since I_{ADJ} current (less than $100\mu\text{A}$) from the adjustment terminal represents an error term, the LM350 was designed to minimize I_{ADJ} and make it very constant with line and load changes. To do this, all quiescent operating current is returned to the output establishing a minimum load current requirement. If there is insufficient load on the output, the output voltage will rise.

Since the LM350 is a floating regulator, it is only the voltage differential across the circuit which is important to performance, and operation at high voltage with respect to ground is possible.

Since I_{ADJ} is controlled to less than $100\mu\text{A}$, the error associated with this term is negligible in most applications.

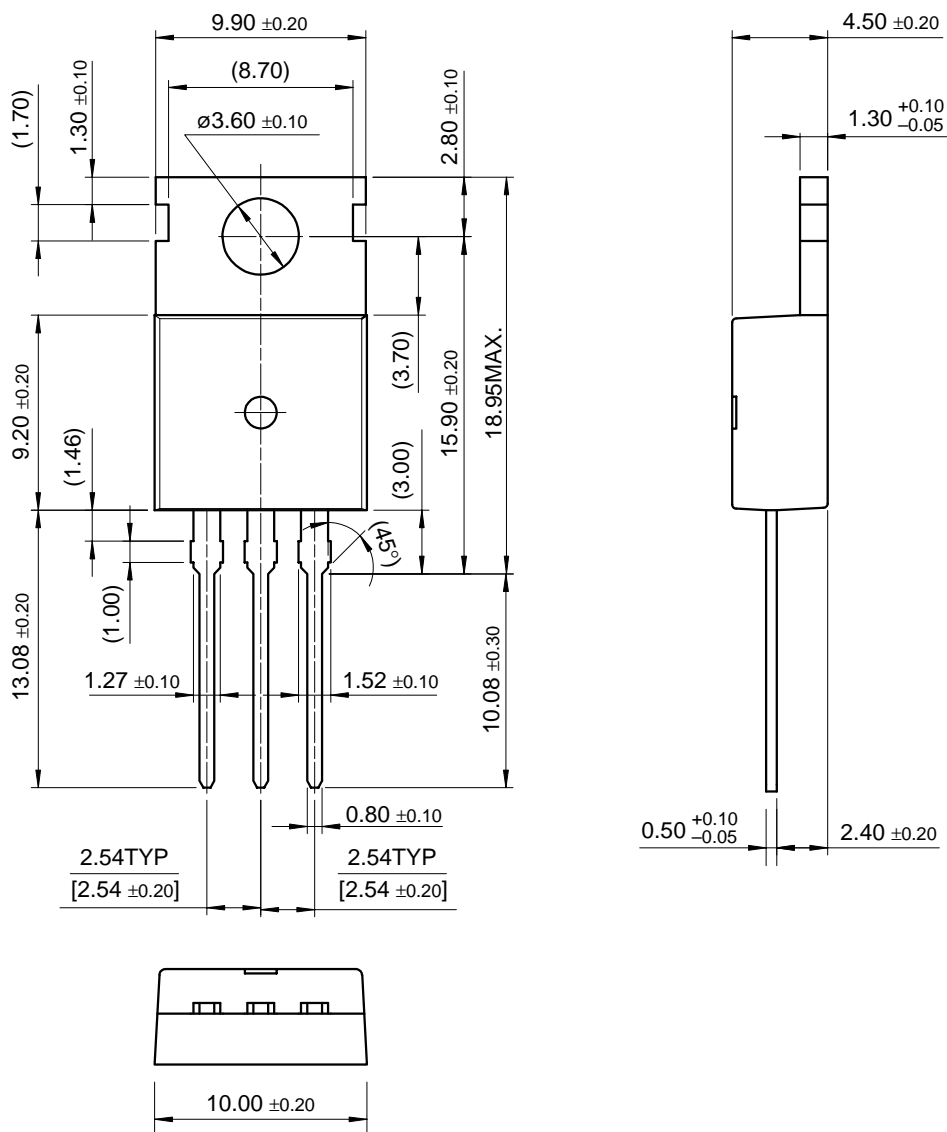
Mechanical Dimensions (Continued)**Package****TO-220**

Ordering Information

Product Number	Package	Operating Temperature
LM350T	TO-220	0°C to + 125°C

DISCLAIMER

FAIRCHILD SEMICONDUCTOR RESERVES THE RIGHT TO MAKE CHANGES WITHOUT FURTHER NOTICE TO ANY PRODUCTS HEREIN TO IMPROVE RELIABILITY, FUNCTION OR DESIGN. FAIRCHILD DOES NOT ASSUME ANY LIABILITY ARISING OUT OF THE APPLICATION OR USE OF ANY PRODUCT OR CIRCUIT DESCRIBED HEREIN; NEITHER DOES IT CONVEY ANY LICENSE UNDER ITS PATENT RIGHTS, NOR THE RIGHTS OF OTHERS.

LIFE SUPPORT POLICY

FAIRCHILD'S PRODUCTS ARE NOT AUTHORIZED FOR USE AS CRITICAL COMPONENTS IN LIFE SUPPORT DEVICES OR SYSTEMS WITHOUT THE EXPRESS WRITTEN APPROVAL OF THE PRESIDENT OF FAIRCHILD SEMICONDUCTOR CORPORATION. As used herein:

1. Life support devices or systems are devices or systems which, (a) are intended for surgical implant into the body, or (b) support or sustain life, and (c) whose failure to perform when properly used in accordance with instructions for use provided in the labeling, can be reasonably expected to result in a significant injury of the user.
2. A critical component in any component of a life support device or system whose failure to perform can be reasonably expected to cause the failure of the life support device or system, or to affect its safety or effectiveness.